

Data Sheet



Article number: 20343307

Description: E+G Handwheel
GN 322-140-K16-A

Measures

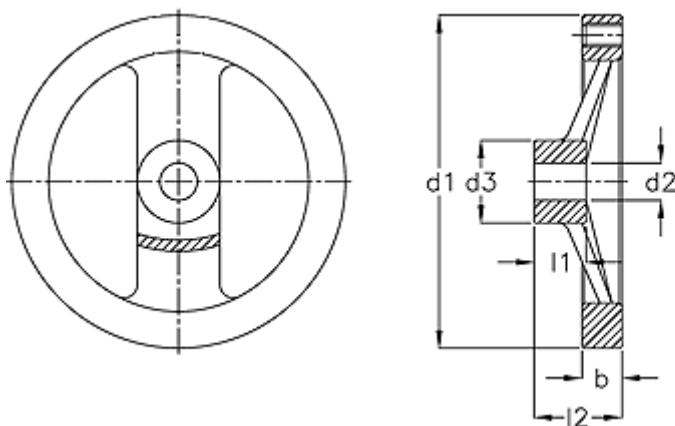

b = 16.5

d1 = 140

d2 H7 = 16

d3 = 36

l1 = 19

l2 = 36